

## **RPG Dual Polarization Dual Frequency Scanning Cloud Radar Systems: Configurations and Applications**

Edited by Dr. Alexander Myagkov and Dr. Thomas Rose



**Radiometer Physics**  
A Rohde & Schwarz Company

## **Novel Product Line FMCW Cloud Radars**

---



## **Benefit from high operation frequency**

---

- The operation frequencies of 35 and 94 GHz allows for reaching higher sensitivity with smaller form factor than S, C, and X-band radars. Small sizes and low weight of the system permits radars' utilization in mobile measurement platforms.
- Short wavelength and high average transmitted power provide high sensitivities of -47 and 50 dBZe at 5 km with 10 s sampling time at 35 and 94 GHz, respectively.
- Due to proportionality of the Doppler shift to the operation frequency, the radars have a high Doppler resolution down to a few cm/s.

## **Explore operational features gained from frequency modulated**

- The FMCW signal is generated with a solid-state transmitter, which is much cheaper and more reliable than those based on a vacuum tube, which is often used in pulsed cloud radars.
- The radar transmitter does not use high voltages, which are often required in pulsed systems and may cause a failure of an instrument during operation in humid conditions due to high voltage discharges.
- Low peak power in the order of several Watts is less critical for electromagnetic compatibility. The transmitted power density satisfies European regulations (less than 50 W/m<sup>2</sup>, directive 2013/35/EU).
- Digital signal formation eliminates variations of the signal shape, which may occur but is not always monitored in pulsed systems. In pulsed radars the pulse shape can vary due to transmitter aging. The pulse shape change leads to a mismatch of the receiving filter and, therefore, to sensitivity losses and miss-calibration.
- The radar can measure atmospheric profiles with the spatial resolution down to a few meters, which is often not accessible with pulsed cloud radars.
- A minimum observable range of 50 m and very high range resolution enables detailed observations of boundary layer and fog.
- An automatic gain control excludes receiver saturation in the case of strong precipitation.



**RPG GmbH has several decades of experience in the radiometer business. Now we are transferring our unique knowledge to cloud radar design continuous wave signals**

---

- All mechanical parts of the radar, including antennas, are precisely machined and assembled in-house. Such an approach allows for repeatability and therefore a proper data inter-comparison among produced radars.
- The radar components are installed inside a thermally insulated housing. The physical receiver temperature is stabilized to an accuracy of 500 mK.
- Low system noise temperature of 400 K and 600 K for the Ka-band and W-band configuration, respectively, are achieved by using state-of-the-art receiver components.
- The embedded passive channel allows for measurements of Liquid Water Path (LWP). The passive channel uses the same receiving antenna as the active one and therefore has the same antenna beam width.
- The radar and the passive channel absolute calibration is performed according to techniques applied to passive radiometer design. While long-term stability is achieved by using absolute standards (liquid nitrogen), a short-term calibration is provided by periodical Dicke switching. If a HATPRO radiometer from RPG is available, its calibration can be transferred to the radar.
- The absolute calibration is verified using a metal reference sphere carried by a drone.
- A rain/snow/fog mitigation system based on a powerful dew blower and an optional heater allows for avoiding liquid drops and ice on the hydrophobic antenna radomes. The mitigation system provides high quality measurements in all weather conditions.
- A built-in weather station monitors weather conditions at the ground, which is not only a source of additional information for an analysis, but also a reference for radar based retrieval evaluation.
- A low temperature radar configuration (-40 °C) can be provided.

\*optional



## Configurations and applications

### 1. Vertically pointed single polarization configuration (RPG-FMCW-94/35-SP)

#### Measured parameters

Moment data: Reflectivity, Mean radial velocity, Spectrum width, Skewness, Kurtosis

Spectral data: Reflectivity spectra

Table 1. Provided radar products



Fig. 1. The new scanner compatible design of the vertically pointed system.

Note: dimensions do not include the stand.

Length: 1150 mm  
Width: 900 mm  
Height: 900 mm  
Weight: 180 kg

Fig. 2. A version of the radar for installations on mobile platforms. Smaller antennas are available upon request.



➤ *Calibration of weather and cloud radars including air and space-borne systems*

As the radar is absolutely calibrated with the same technique as passive radiometers, it can be used to calibrate radar systems of other types, e.g. pulsed magnetron based radars. The hardware performance of such radars often depends on environmental conditions and aging components. The calibration of these radars with a target with known scattering properties has its limitations (a radar does not have a scanner, far field requirement). Not only cloud radars but also operational S, C, and X band precipitation radars can be calibrated. The calibration using RPG-FMCW-94-SP can be performed by comparing reflectivity values, when the same part of a cloud is observed. Operating nearly the same frequency as many satellite-based cloud radars, the RPG-FMCW-94-SP is a good reference for data evaluation. For instance, using the same frequency would mitigate differences in measured reflectivity associated with resonance scattering effects.

➤ *Evaluation of local cloud resolving models.*

The cloud radar provides vertical profiles of the radar reflectivity factor with high temporal (~1 s) and spatial resolution (down to a few meters). These profiles contain information about cloud geometry, i.e. number of cloud layers present, cloud top altitude, thickness, and presence of precipitation. An example of such observations is shown in Fig. 3. The radar's high range resolution is important for a characterization of low level liquid clouds and fog layers. In addition, existing reflectivity based algorithms allow for retrieving ice and liquid water contents of detected clouds (Note: additional instrumentation may be required). Long term observations of cloud and fog statistics, IWC, and LWC represent a valuable data set that is a good reference for the validation of existing local weather prediction and cloud resolving models (Illingworth et al., 2007).

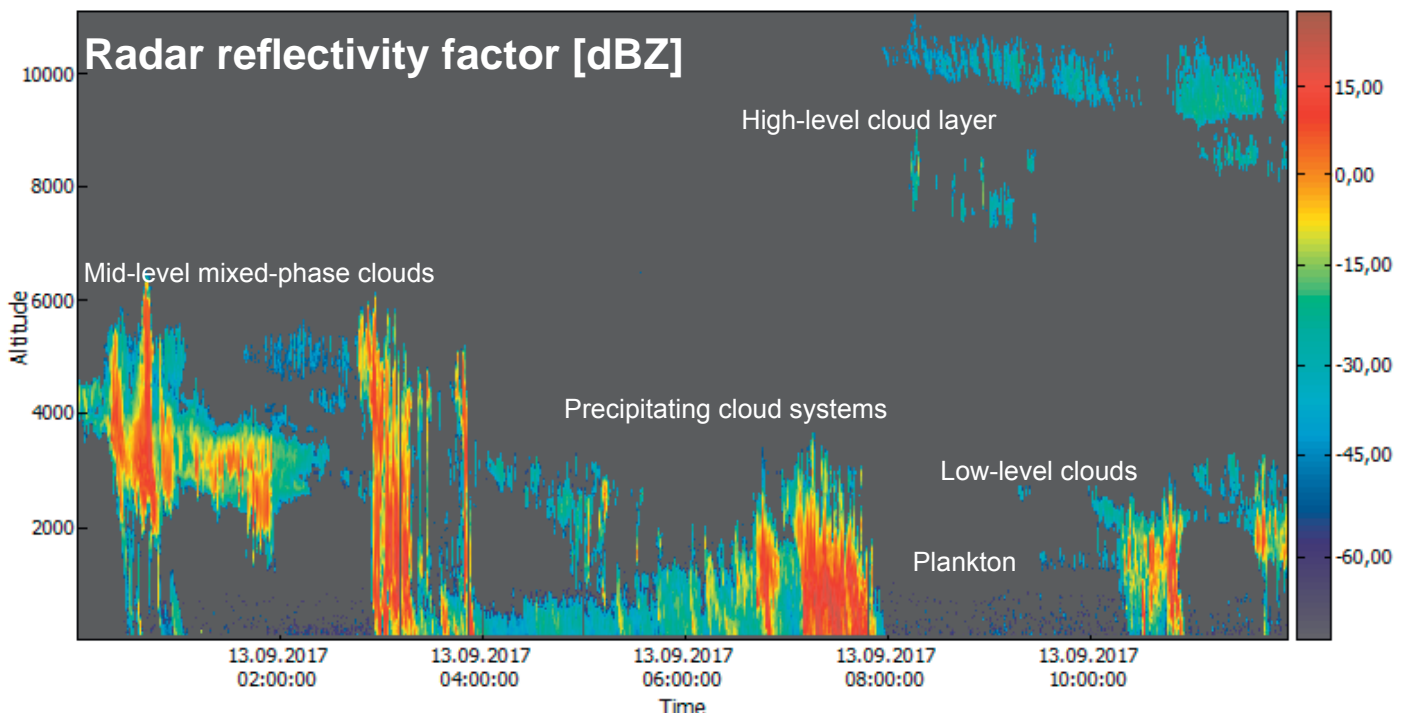

Fig. 3. The time-range cross section of the radar reflectivity factor. The measurements were taken on 13 Sep 2017 at the RPG site, Meckenheim, Germany

➤ *Development and improvement of microphysical retrievals for clouds*

A number of studies have shown that qualitatively new algorithms should be based on radar Doppler spectra and their moments. The operation frequency of 94 GHz allows for measurements of Doppler spectra with high Doppler resolution (typically around 1.7 cm/s). Such measurements are a base for the development of advanced algorithms for the detection of supercooled liquid water in mixed-phase clouds (Luke et al., 2010). An example how supercooled liquid water may look like in a Doppler spectrum is shown in Fig. 4. In general, supercooled liquid particles are small in size and therefore

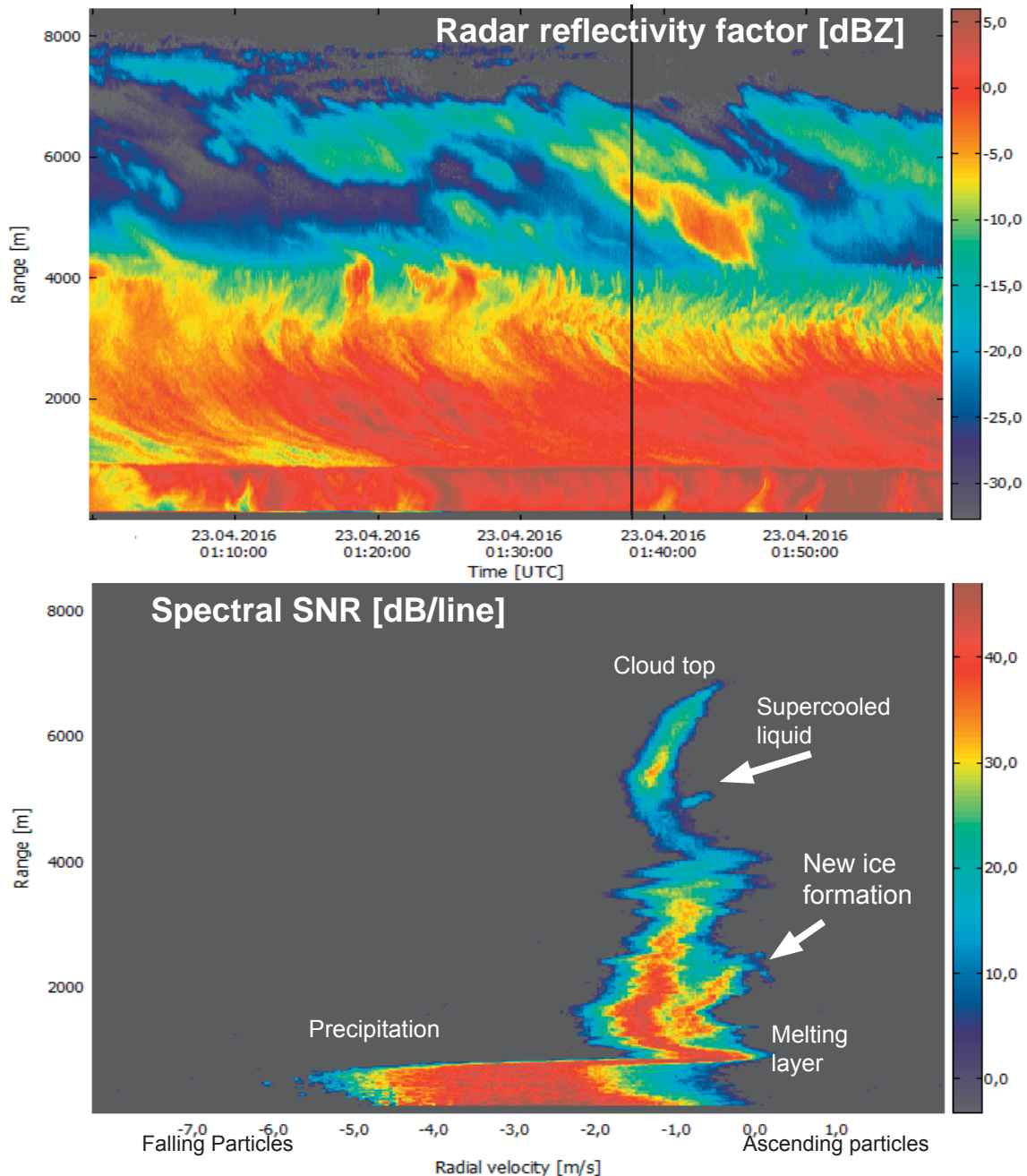

Fig. 4. The time range cross section of the radar reflectivity factor (upper panel) and the vertical profile of Doppler spectra for a deep precipitating cloud system observed on 23 Apr 2016 at the RPG site, Meckenheim, Germany. The vertical black line indicates the time sample corresponding to the Doppler spectrum profile.

fall slower than large ice particles. Thus, supercooled liquid can appear in Doppler spectra as a secondary peak. Often the presence of supercooled liquid is masked by newly formed pristine ice crystals and a secondary peak in spectra is related to ice particles. Nevertheless, at mid-level it is an indication of liquid dependent ice formation. High resolution Doppler spectra also represent valuable information for a quantitative characterization of cloud particles (Shupe et al., 2004). Accurate absolute calibration of the radar system mitigates uncertainties associated with the radar hardware in existing reflectivity based retrievals. A high spatial resolution is of benefit for tracking an evolution of a particle's population from cloud top to cloud bottom.

➤ *Correction of wind profiler observations for precipitation*

In the case of precipitating clouds, Doppler spectra measured by a wind profiler are influenced by large falling particles. Thus, the estimated vertical air velocities are often contaminated. At the same time, cloud radar Doppler spectra are formed mostly by cloud particles and do not contain significant contributions from scattering by air inhomogeneities. Therefore, these spectra can be used for mitigation of the particle influence to the wind profiler observations [Bühl et al., 2015].

➤ *Characterization of boundary layer height*

High sensitivity of the radar to atmospheric plankton (insects, seeds, pollen, etc.), which is carried by air motions in the lowest part of the atmosphere, allows for an estimation of the Planetary Boundary Layer (PBL) height at certain environmental conditions (warm season, day time, no clouds within the PBL). Doppler measurements also provide an information about turbulent motions within PBL.

➤ *Understanding of mixed-phase cloud formation*

It is known that most ice crystals in mixed-phase clouds are formed within supercooled liquid layers. Long lasting nature of supercooled water is related to updrafts which sustain the liquid layer by lifting water vapor. Therefore, vertical air motions play an important role for the formation of mixed-phase clouds. Using the fact that cloud particles at the cloud top, where ice formation is initiated, are small, their vertical movements are mostly dominated by air motions. Having Doppler capabilities, the radar can be used for detection and characterization of up- and downdrafts (Shupe et al., 2008). An example of mean radial velocity observations for a mixed-phase cloud is shown in Fig. 5.

➤ *Development of quantitative precipitation and drizzle estimates*

The radar Doppler spectra can be used to detect and characterize precipitation and drizzle (Luke and Kollias, 2013). Doppler spectra contain information about size distribution. An example of bimodal raindrop distribution is shown in Fig. 6. In case the size of liquid drops exceeds 1 mm, resonance scattering effects occur (see Fig. 7). This provides a reference for size determination of raindrops even in light intensity precipitation. At certain conditions the melting layer can be detected (a reliable detection is only possible with the dual polarization version). The embedded weather station provides precipitation intensity at the ground, which can be used to establish reflectivity-rain intensity relationships.



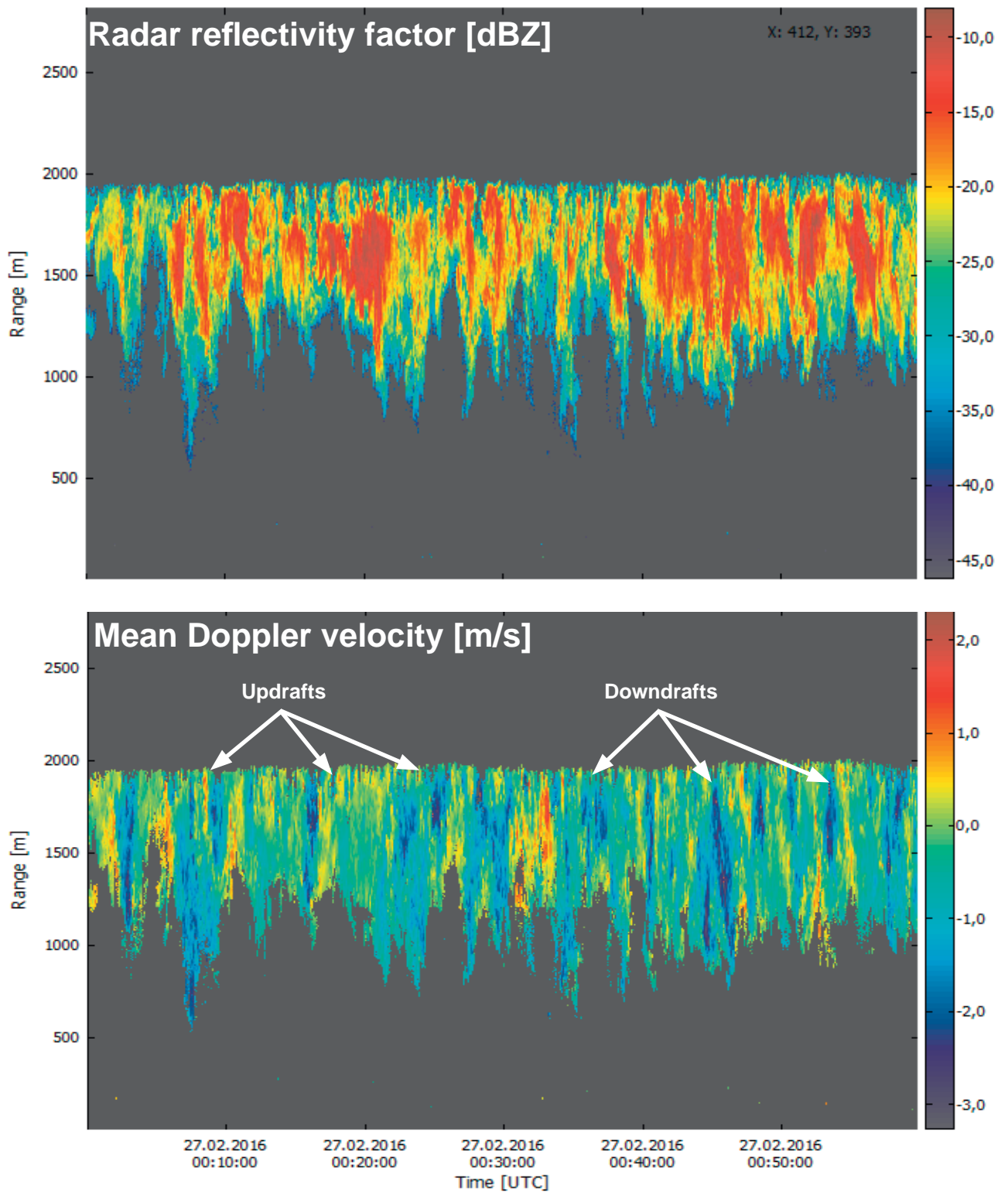

Fig. 5. The time range cross sections of the radar reflectivity factor (upper panel) and the mean Doppler velocity. The measurements were taken on 27 February 2016 at the RPG site, Meckenheim, Germany.

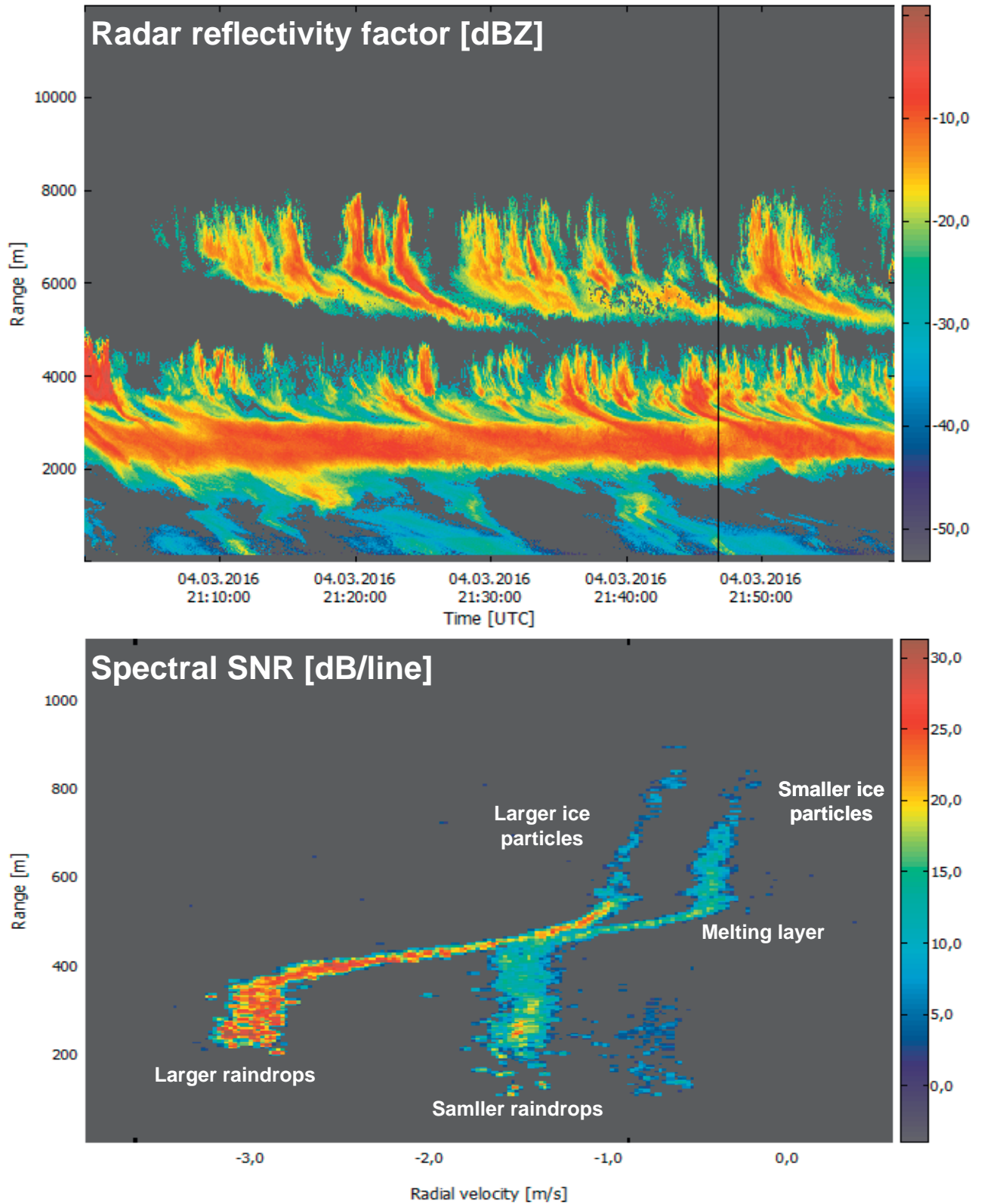

Fig. 6. The time range cross section of the radar reflectivity factor (upper panel) and the vertical profile of Doppler spectra for a cloud system observed on 4 March 2016 at the RPG site, Meckenheim, Germany. The vertical black line indicates the time sample corresponding to the Doppler spectrum profile.

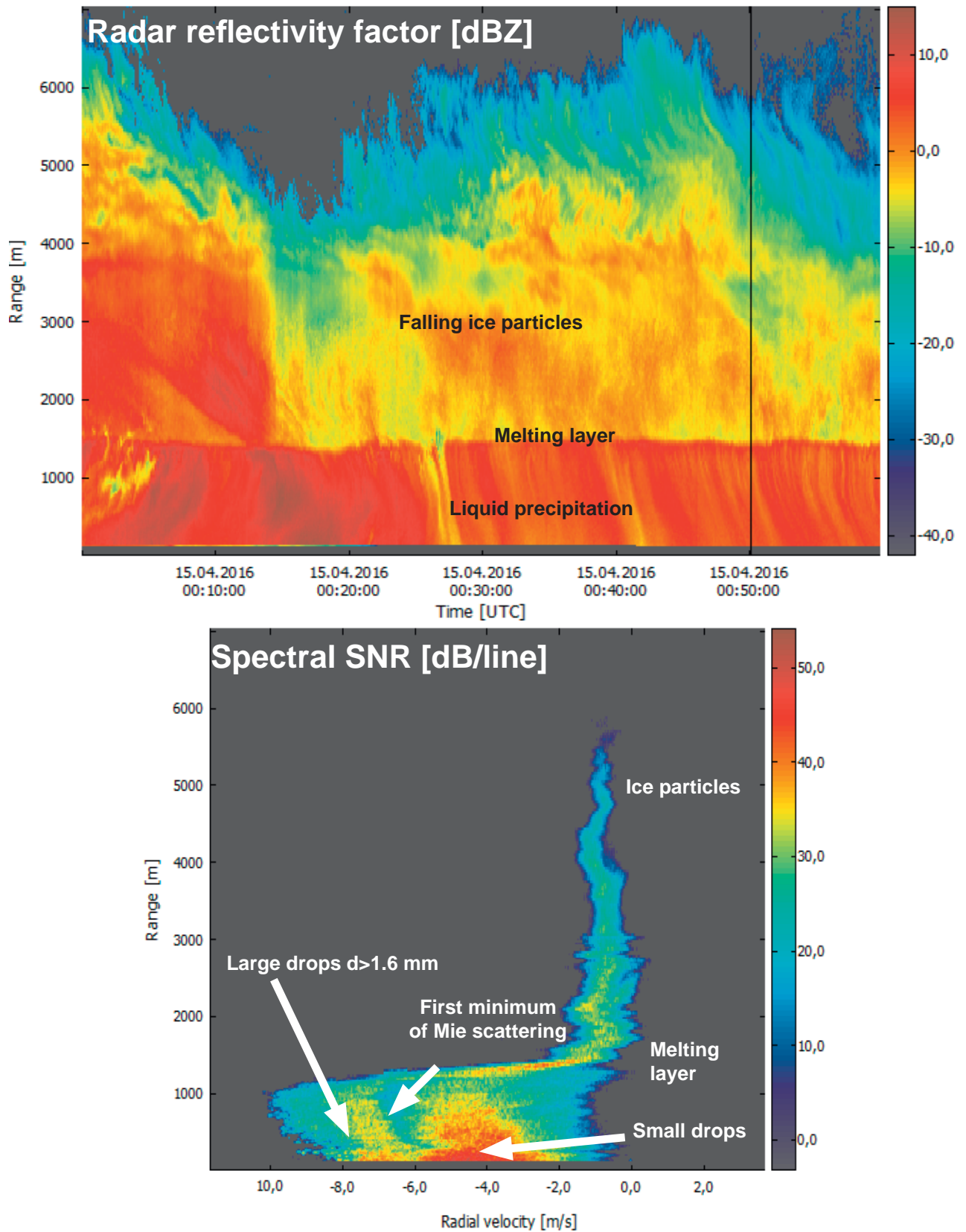

Fig. 7. The time range cross section of the radar reflectivity factor (upper panel) and the vertical profile of Doppler spectra for a cloud system observed on 15 April 2016 at the RPG site, Meckenheim, Germany. The vertical black line indicates the time sample corresponding to the Doppler spectrum profile.

➤ *Synergistic use in an observation platform*

Capabilities of the single polarization vertically pointed radar are significantly broadened when it is used in a measurement platform including a lidar and a microwave radiometer. Such platforms can be included into existing networks such as CLOUDNET (Illingworth et al., 2007). This network provides a MATLAB-based software performing cloud particle's classification and microphysical retrievals for ice and liquid phase.

35 GHz cloud radars are deployed at many observational sites. Its synergistic use with the 94 GHz cloud radar yields additional information that can be used for characterization of ice particle's shape (Kneifel et al., 2015), detection of internal supercooled liquid layers, and attenuation-based retrieval of LWC (Matrosov, 2009).

Collocated Doppler observations with the radar, a wind lidar, and a wind profiler can be used to separate terminal velocity of cloud particles and vertical air motions [Bühl et al., 2015]. This is an important step towards converting radar Doppler spectra into size distribution of cloud particles using known size-terminal velocity relations.

## 2. Scanning single polarization configuration

(available from the beginning of 2017)

### Measured parameters

Moment data: Reflectivity, Mean radial velocity, Spectrum width, Skewness, Kurtosis

Spectral data: Reflectivity spectra

Table 2. Provided radar products



Length : 1500 mm  
Width: 900 mm  
Height: 1400 mm  
Weight : 300 kg



Fig. 8. The W-band cloud radar with the scanning unit.

In addition to applications given on pp. 5-12, a scanning version of the single polarization radar provides the following possibilities:

- *Continuous characterization of air dynamics with high temporal resolution (down to 60 s)*

The scanning radar allows for vertical profiling of horizontal wind (direction and velocity) within cloud and plankton layers (see. Fig.9 and 10). The estimation of wind employs the harmonic analysis of VAD (Velocity-Azimuth Display), which is based on azimuthal scans (Browning and Wexler, 1968). Moreover, the analysis provides information about presence of convergence/divergence and deformation.

- *Detection of conditions critical for regional airplanes*

Wind shear is considered as one of the processes inducing turbulence. Turbulence is not only harmful for small aircrafts, but it is also one of the requirements for the presence of supercooled liquid particles in the atmosphere. Supercooled liquid drops also have a negative impact on airplane performance. Thus, detection of wind shears with the cloud radar can provide additional warning information for civil aviation.

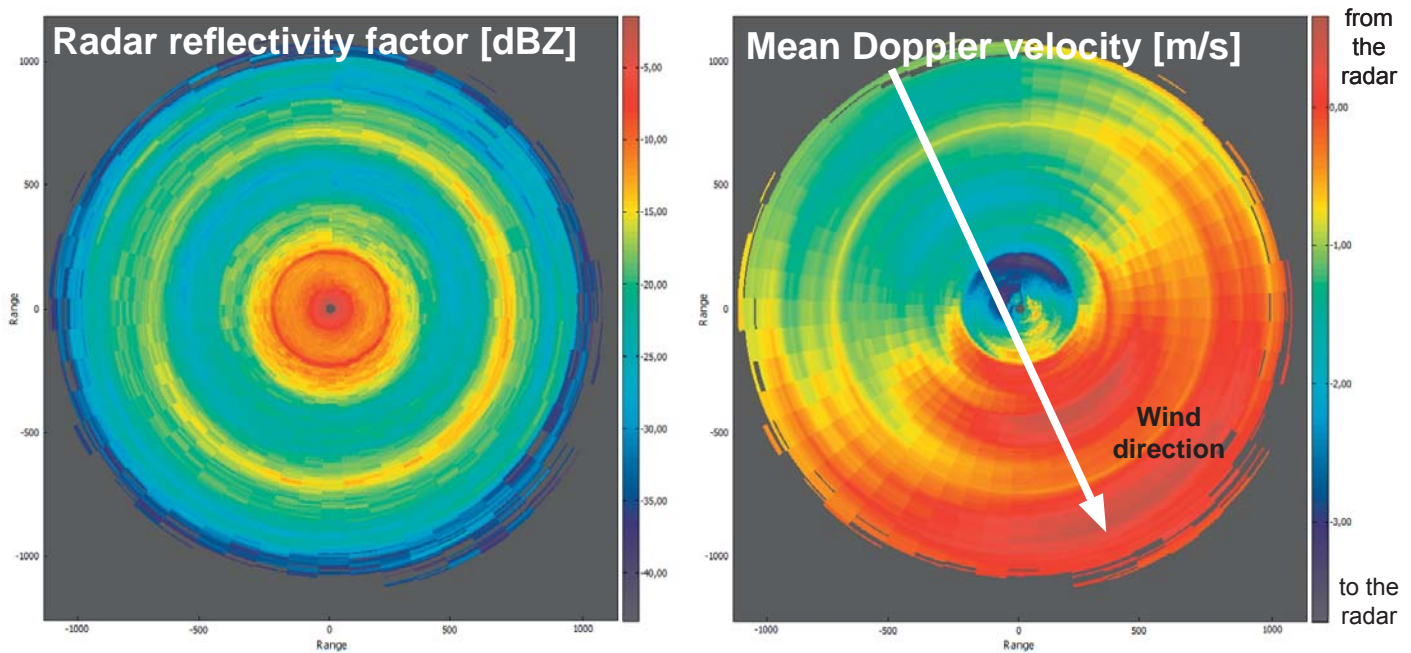

*Fig. 9. Example of azimuthal scanning observations. Radar reflectivity factor (left panel) and mean radial Doppler velocity (right panel). The measurements were performed at the 80 deg elevation angle.*

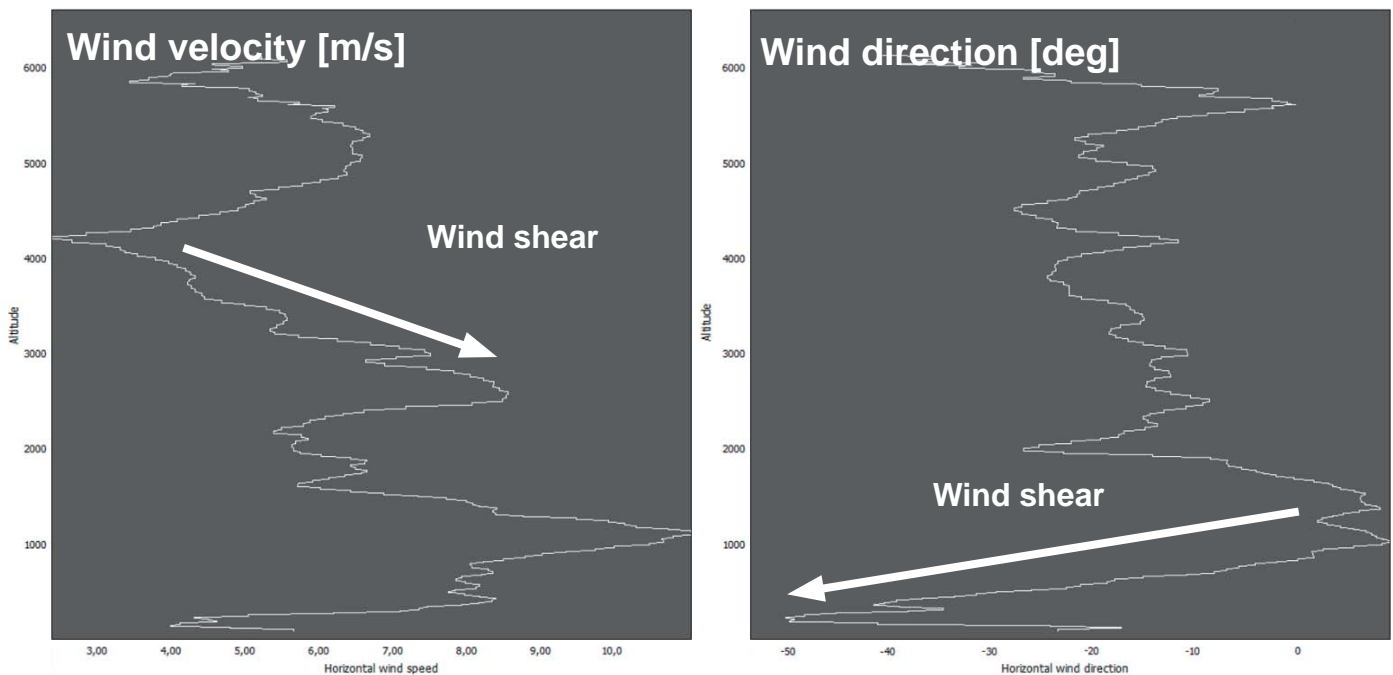

Fig. 10. Example of the wind retrieval corresponding to the measurements from Fig.10.

➤ *Investigation of fog*

High sensitivity to tiny particles (-60 dBZe at 500 m with 5 m resolution and 3 s time sampling rate) and range resolution down to 1 m makes the scanning radar to be an important tool for investigation of fog layers. Well pronounced linear dependence of the signal attenuation on liquid water content provides a good reference for a validation of fog predicting models and radar-based estimates of visibility.

➤ *3D cloud reconstruction*

Modern radiative transfer models take into account effects occurring at cloud edges. In order to evaluate the representation of such effects, observations of the whole cloud volume are required (Lamer et al, 2014). The scanning unit of the radar allows for the implementation of different types of scanning cycles, including changing azimuthal and elevational angles. Thus, the radar can be used to capture the cloud's 3D structure.

➤ *Now-casting of precipitation at small spatial scale*

Having scanning capabilities and providing information on the wind direction and the particle's sedimentation velocity the radar can be used as a tool for short term forecasting of precipitation at ranges up to 15 km. Such a forecast would be much more detailed due to the higher range and angular resolution than those of operational weather radars.

### 3. Vertically pointed dual polarization configuration

Measured parameters	
Moment data:	Reflectivity, Mean radial velocity, Spectrum width, Skewness, Kurtosis
Integrated polarimetric data:	Linear depolarization ratio (LDR), co-cross-channel correlation coefficient $\rho_{cx}$
Spectral data:	Reflectivity spectra
Spectral polarimetric data:	sLDR, $sp_{cx}$

Table 3. Provided radar products

In addition to applications given on pp. 5-12 the dual polarization version of the vertically pointed radar provides the following possibilities (Note, that applications given on pp. 13 and 14 cannot be implemented):

➤ *Efficient clutter removing*

Ground clutter and plankton often hamper reliable detection of clouds. This is especially important for detection of fog and low level clouds that are characterized by reflectivity values comparable to those of clutter. The dual polarization configuration of the radar allows for measurements of LDR, which values are high for clutter but low for cloud particles. In a presence of strong updrafts plankton may be lifted above the melting layer. For such cases LDR cannot be used for reliable clutter removal. Taking into account that plankton can be often considered as a point target and cloud particles represent volume distributed targets, the advanced processing based on  $\rho_{cx}$  (Myagkov et al., 2015) was implemented in order to discriminate between clutter and clouds.

➤ *Detection of the melting layer*

The melting layer, corresponding to the zero degree isotherm, is a cloud area where falling ice particles are melting. At millimeter wavelengths the melting layer cannot always be reliably detected from vertical profiles of radar reflectivity factor or spectra moments. Nevertheless, it is characterized by strong depolarization of radar signals. Therefore, vertical profiles of LDR are used in order to estimate the melting layer height. The height of the melting layer is often used for separation of areas with liquid and solid cloud particles. It is a good indicator of rapid changes of temperature in convective precipitating cloud systems. Also, knowledge about the melting layer can be used as an additional input parameter for radiometer based retrievals of temperature and relative humidity profiles. Often, microphysical retrievals and models employ radiosondes launched not directly from the measurement site but from a station located several kilometers away. For such cases, continuous observations of the melting layer can be used for consistency checks of radiosonde temperature profiles. Finally, the melting layer height can be helpful for estimation of avalanche likelihood in mountain areas.

➤ *Basic classification of scatterers*

Using LDR and  $\rho_{cx}$  the radar classifies atmospheric scatterers into several types: liquid precipitation, melting layer (mixed-phase scatterers), ice particles, ice columns, plankton, and chaff.

➤ *Detection of lightning activity*

Within thunderstorm clouds strong electric fields can be induced. These fields often align a number of ice particles in a certain direction. In general, the alignment direction does not coincide with the polarization plane of the radar signal and, therefore, LDR values measured by the radar are enhanced. Thus, polarimetric observations with the radar might be interesting for research on atmospheric electricity as they not only show detected lightning events but also provide the altitude at which lightning occurs.

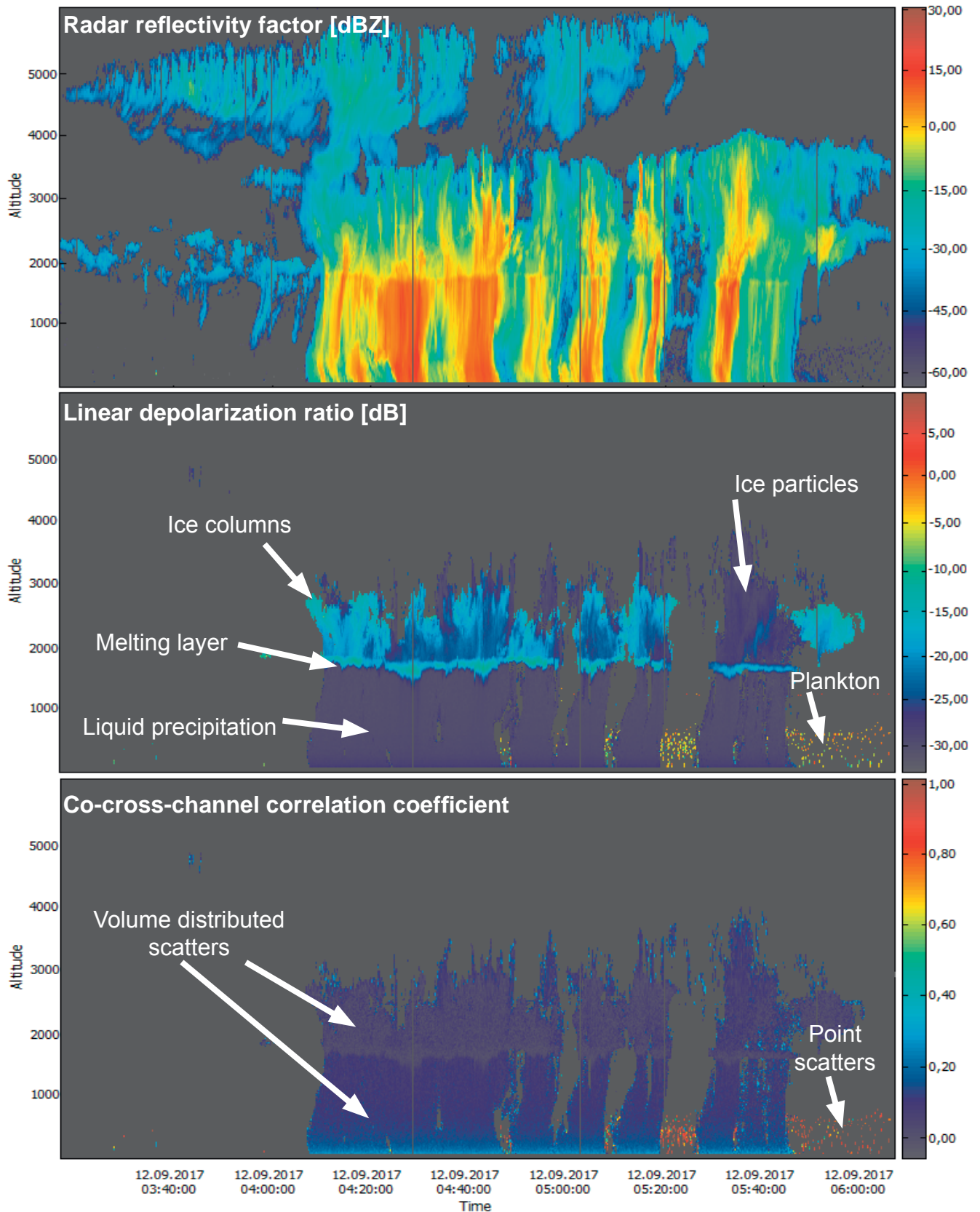

Fig. 11. Example of polarimetric observations in the LDR-mode. Time-height cross-sections of the radar reflectivity (upper panel), linear depolarization ratio (middle panel), and co-cross-channel-correlation coefficient (lower panel). During the measurements the radar was pointed vertically. Measurements were taken at the RPG site, Meckenheim, Germany.



➤ *Hail detection*

Hail particles induce increased values of LDR in the whole altitude range from the melting layer to the ground. Information about the hail presence is valuable for a validation of weather prediction models and weather radar based hail warning systems.

## 4. Scanning dual polarization configuration

(available from the beginning of 2017)

Measured parameters	
Moment data:	Reflectivity, Mean radial velocity, Spectrum width, Skewness, Kurtosis
Integrated polarimetric data:	Differential reflectivity ( $Z_{DP}$ ), Cross-channel correlation coefficient $\rho_{hv}$ , Differential phase shift $\Phi_{DP}$ , Differential attenuation $A_{DR}$ , Propagational differential phase shift $K_{DP}$ , Slanted Linear depolarization ratio (SLDR), co-cross-channel correlation coefficient in the slanted basis $\rho_{cx}$
Spectral data:	Reflectivity spectra
Spectral polarimetric data:	$sZ_{DR}$ , $s\rho_{hv}$ , $s\Phi_{DP}$ , $sSLDR$ , $s\rho_{cx}$

Table 4. Provided radar products

The scanning dual polarization configuration of the radar combines all the applications given on pp. 5 - 17. In addition the following possibilities are applicable (Note: applications given on pp. 15 and 17 can be implemented for much larger areas):

➤ *Advanced particles classification*

The ability of the radar to measure a set of polarimetric variables similar to the one provided by operational weather radars can be used for a more accurate classification of cloud scatterers and precipitation with high spatial, temporal, and angular resolution over areas of 300 km<sup>2</sup>. Spectral polarimetry is useful for classification of different types of particles present in the same resolution volume.

➤ *Estimation of shape and orientation of cloud scatterers*

Using well known spheroidal approximation quantitative parameters characterizing shape and orientation of cloud particles at temperatures warmer than -20°C are retrieved from spectral polarimetric variables [Myagkov et al., 2016]. The retrieval can be applied separately for different types of particles in case they are detected in the same volume.

➤ *Improved estimation of rain drop size distribution*

Size distribution of liquid drops is an important characteristic of rain. Existing retrievals based on radar Doppler spectra and known size-terminal velocity relations can show large discrepancies. A lack of information on vertical air motions hampers the estimation of particle's size. Using the fact that at 3.2 mm wavelength rain drops with size larger than 1 mm in diameter produce distinct polarimetric scattering properties (oscillation behavior due to resonance effects, see Fig. 13), the spectral polarimetric variables measured by the radar can be used for a more accurate size estimation. A precise absolute calibration of the radar reduces the uncertainty in number concentration estimates.



➤ *Estimation of vertical air motions in rain*

Vertical air motions are one of the main drivers of precipitation as they are responsible for lifting moisture upwards. Instruments with Doppler capabilities such as a lidar, a weather radar, and a wind profiler cannot provide reliable information about vertical wind in liquid precipitation. Nevertheless, knowledge of drop sizes from cloud radar spectral polarimetry enables utilization of the difference between the measured falling velocity and the one expected for a certain size as an indicator of up and downdrafts.

➤ *Novel quantitative precipitation estimation*

The cloud radar spectral polarimetry provides a qualitatively new possibility for estimation of liquid precipitation intensity. First, size distributions of rain drops measured with high temporal resolution can be directly converted to the rain rate. Second, the estimate can be evaluated and corrected using propagation variables such as the differential attenuation and propagation differential phase shift that are proportional to the mass of liquid water. Separation of propagation and backscattering effects, which is a challenge for polarimetric weather radars, is respectively easy when polarimetric variables with high spectral resolution are available. Last but not least, the quality of the retrieved rain intensity can be checked with the built-in weather station.

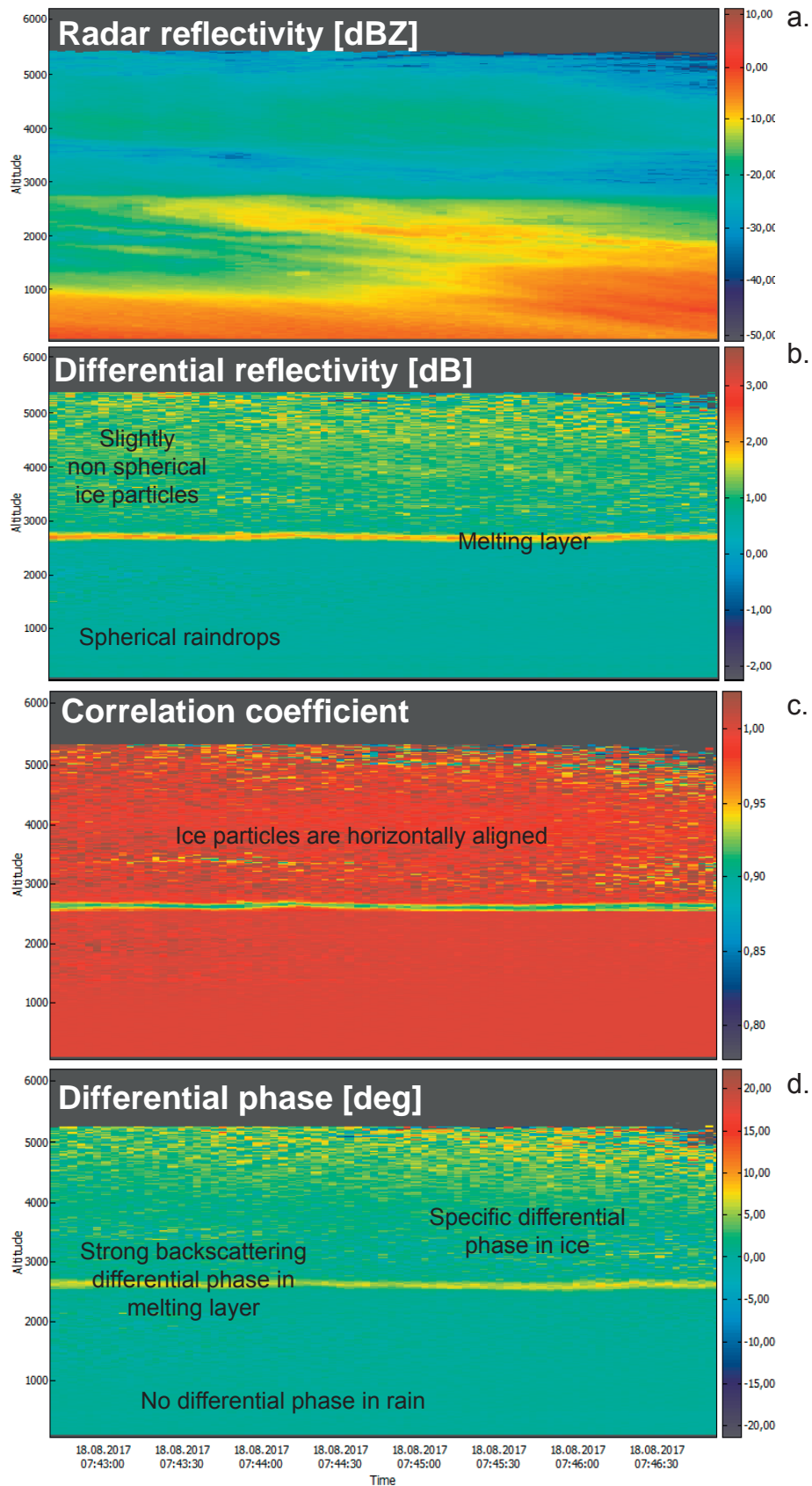

Fig. 12. Example of polarimetric observations in the STSR-mode. Time-height cross-sections of the radar reflectivity (a.), differential reflectivity (b.), correlation coefficient (c.), and differential phase shift (d.). Observations were made at 30 deg elevation angle. Measurements were taken at the RPG site, Meckenheim, Germany.

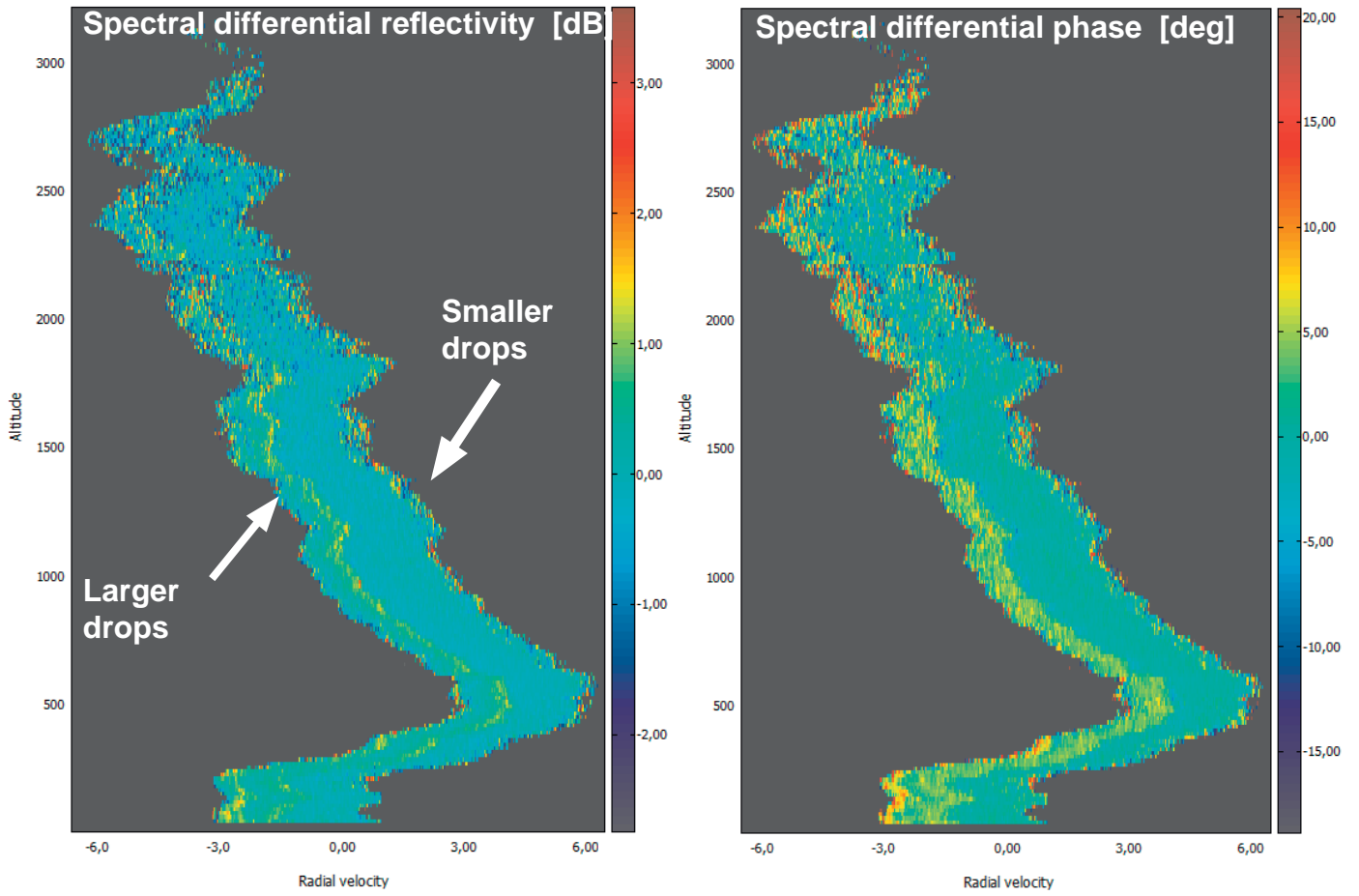
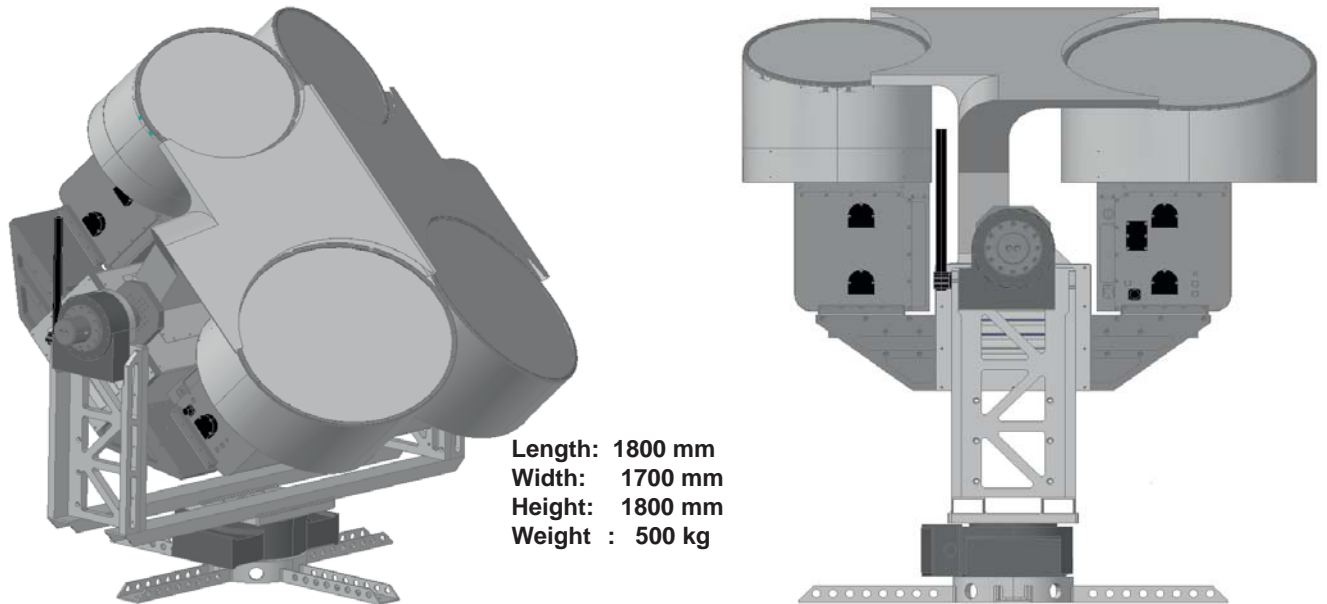

Fig. 13. Spectral polarimetric observations at 30 deg elevation in the STSR-mode. Spectral differential reflectivity and spectral differential phase vertical profiles. Measurements were taken at the RPG site, Meckenheim, Germany.

## 5. Dual frequency configuration (available from 2018)



*Fig. 14. Design of the dual wavelength radar system.*

The RPG W-band cloud radar can be complemented by a RPG Ka-band FMCW radar (35 GHz) that has a similar form factor and can be set up at the same scanning platform as the W-band radar. Having a combination of two frequencies such system will additionally provide measurements of the dual wavelength ratio. Due to different absorption by liquid water at Ka and W bands, the dual wavelength ratio can not only indicate a presence of supercooled liquid layers in mixed-phase clouds but also provides information about liquid water content. As the system also has the passive channel at 89 GHz the continuous consistency checks of measured liquid water content profiles with retrieved liquid water path can be performed. The dual wavelength configuration can also be employed for characterization of size and shape of particles producing non-Rayleigh scattering. Note: the Ka-band radar can be also provided as a single instrument having the same configurational options as the W-band radar (see pp. 5 - 20).



## Specifications for RPG-FMCW-94 Radar

Parameter	Specification
Centre Frequency	94 GHz ( $\lambda=3.19$ mm) $\pm$ 100 MHz typical
IF range	0.3 to 3.7 MHz
Transmitter power	1.5 W typical (solid state amplifier)
Antenna type	Bi-static Cassegrain with 500 mm aperture
Antenna gain	50.1 dB
Beam width	0.56° FWHM
Polarisation	V (optional V & H)
Rx System Noise Figure	4.5 dB (500 K system noise temperature)
Typical Dynamic range (sensitivity) with 1.5 W transmitter @ 10 s sampling time	-50 dBz to +20 dBz (at 5 km height / 30 m resolution)
Ranging	50 m to 12 km typical, 15 km maximum
Vertical resolution	Typ. 15-30 m (down to 1m is possible for a limited altitude range)
Calibrations (automatic)	Transmitter power monitoring and receiver Dicke switching for gain drift compensation (radar and passive channel)
Calibrations (maintenance)	Liquid nitrogen receiver calibration
Calibration verification	External reference sphere
A/D Sampling rate	12 MHz (data processing between 0.35 and 4.5 MHz)
Data processing system	High-Performance embedded PC
Sampling rate (full profiles)	Adjustable: $\geq$ 1 second
Doppler range	$\pm$ 9 m/s unambiguous velocity range (0-2500 m), $\pm$ 4.2 m/s above
Doppler resolution	$\pm$ 1.5 cm/s or better
Chirp variations	3 typical, 5 possible, re-programmable
Passive channels	89 GHz for integral LWP detection
Control connection	TCP/IP connectivity via fibre optics data cable to internal PC
Operation software	Real time visualization, real time data extraction, real time control (adaptive observation modes depending on context), data archiving, radar can be operated in stand-alone mode
Data products	See Tables 1 - 4
Data formats	netCDF (CF convention), proprietary binary
Mitigation system for rain/fog/dew	Strong dew blower (approx. 4000 m <sup>3</sup> /h), radomes with hydrophobic coating, optional heater (additional 2 kW)
Additional sensors	Automatic weather station with P, T, RH, RR, Snow, WS, WD
Scanning	Scanner unit for full sky scanning capability with maximum angular velocity of 6 °/s in azimuth and elevation



## Specifications for RPG-FMCW-35 Radar

Parameter	Specification
Centre Frequency	35 GHz ( $\lambda=8.6$ mm) $\pm$ 100 MHz typical
IF range	0.3 to 3.7 MHz
Transmitter power	10 W (solid state amplifier)
Antenna type	Bi-static Cassegrain with 700 mm aperture
Antenna gain	45 dB
Beam width	1° FWHM
Polarisation	V (optional V & H)
Rx System Noise Figure	4 dB (400 K system noise temperature)
Typical Dynamic range (sensitivity) with 1.5 W transmitter @ 10 s sampling time	-47 dBz to +30 dBz (at 5 km height / 30 m resolution)
Ranging	50 m to 12 km
Vertical resolution	Typ. 15-30 m (down to 1m is possible for a limited altitude range)
Calibrations (automatic)	Transmitter power monitoring and receiver Dicke switching for gain drift compensation (radar and passive channel)
Calibrations (maintenance)	Liquid nitrogen receiver calibration
Calibration verification	External reference sphere
A/D Sampling rate	12 MHz (data processing between 0.3 and 3.7 MHz)
Data processing system	High-Performance embedded PC
Sampling rate (full profiles)	Adjustable: $\geq$ 1 second
Doppler range	$\pm$ 10 m/s
Doppler resolution	$\pm$ 4 cm/s or better
Chirp variations	3 typical, 5 possible, re-programmable
Passive channels	32 GHz for integral LWP detection
Control connection	TCP/IP connectivity via fibre optics data cable to internal PC
Operation software	Real time visualization, real time data extraction, real time control (adaptive observation modes depending on context), data archiving, radar can be operated in stand-alone mode
Data products	See Tables 1 - 4
Data formats	netCDF (CF convention), proprietary binary
Mitigation system for rain/fog/dew	Strong dew blower (approx. 4000 m <sup>3</sup> /h), radomes with hydrophobic coating, optional heater (additional 2 kW)
Additional sensors	Automatic weather station with P, T, RH, RR, Snow, WS, WD
Scanning	Scanner unit for full sky scanning capability with maximum angular velocity of 6 °/s in azimuth and elevation



## References:

- Illingworth et al., 2007: Cloudnet, BAMS
- Luke et al., 2010: Detection of supercooled liquid in mixed-phase clouds using radar Doppler spectra, JGR
- Shupe et al., 2004: Deriving Mixed-Phase Cloud Properties from Doppler Radar Spectra, JAOT
- Bühl et al., 2015: Combined vertical-velocity observations with Doppler lidar, cloud radar and wind profiler, AMT
- Shupe et al., 2008: Vertical Motions in Arctic Mixed-Phase Stratiform Clouds, JAS
- Luke and Kollias, 2013: Separating Cloud and Drizzle Radar Moments during Precipitation Onset Using Doppler Spectra, JAOT
- Kneifel et al., 2015: Observed relations between snowfall microphysics and triple-frequency radar measurements, JGR
- Matrosov, 2009: A Method to Estimate Vertically Integrated Amounts of Cloud Ice and Liquid and Mean Rain Rate in Stratiform Precipitation from Radar and Auxiliary Data, JAMC
- Browning and Wexler, 1968: The determination of kinematic properties of a wind field using Doppler radar, JAM
- Lamer et al., 2014: Evaluation of gridded scanning ARM cloud radar reflectivity observations and vertical Doppler velocity retrievals, AMT
- Myagkov et al., 2015: Effects of Antenna Patterns on Cloud Radar Polarimetric Measurements, JTECH
- Myagkov et al., 2016: Cloud radar with hybrid mode towards estimation of shape and orientation of ice crystals, AMT

\*Photo on the title page: Hillary Sanctuary/École Polytechnique Fédérale de Lausanne, Switzerland